

Static contact

CURRENT COLLECTOR DEVICES (CCD)

CCD FOR TRAMWAY WIRELESS

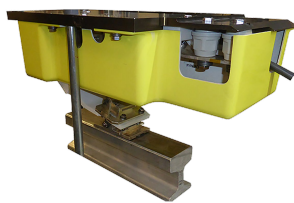

Tramway technology is being more and more used in the development of urban mass transportation projects. The regular Tramway technology uses an alternative energy collection based on a pantograph and catenary but it also exists an energy collection which doesn't need catenary, the wireless technology.

Two technologies enables a current collection from the floor in a dynamic or a static way.

There are numerous advantages of these technologies, some being:

- Aesthetic when the Tramway is next to classified buildings, monuments or historical city centers. The wireless technology will not disfigure the visual environment
- For the security of the firefighters while intervention next to the catenary grid and for the safety of the people doing the maintenance of road public lightning
- Finally to enable extra-large dimensions for road transports.

Mersen innovates and is the first company to propose two different Current Collector technologies wireless (static and dynamic).

The wireless static technology is a Current Collector operating a shoe in contact with a source under the tramway to re-fuel the batteries during Tramway dwelling time.

At each stop the shoe powered by an electronic system is moved down to be in contact with the electrical source. During the 20 seconds a high DC current is re-fueling the Tramway batteries to

FEATURES & BENEFITS

- Visual aesthetic, no more catenary
- Proven technology since 2013 years with more than 18 trains running every day
- CCD's dimensions and characteristics can be customized to your application
- Minimum weight, especially low dynamic mass
- Low noise level
- Extremely compact
- Cost effective, proven technologies and simple fixing
- Low cost maintenance

APPLICATIONS

- Wireless applications for Tramways refueled at the station

STANDARDS

- IEC 61373



Static contact

enable it to go to the next station. Shoe is then moved up and the Tramway can reach the next station.

Since 2013 eighteen trains are using this proven technologies in the world and 21 additional will come very soon.

References

Nice (FR), Luxembourg (LX), Zaragoza (ES)

TECHNICAL DATA OVERVIEW

Voltage DC	750 VDC
Amper (A)	1600 A
Working Temperature	-10°C / +25°C
Pressure of the Shoe	500N \pm 20%
Humidity	90%

DIMENSIONS

Static current collector device Dwg 1027383

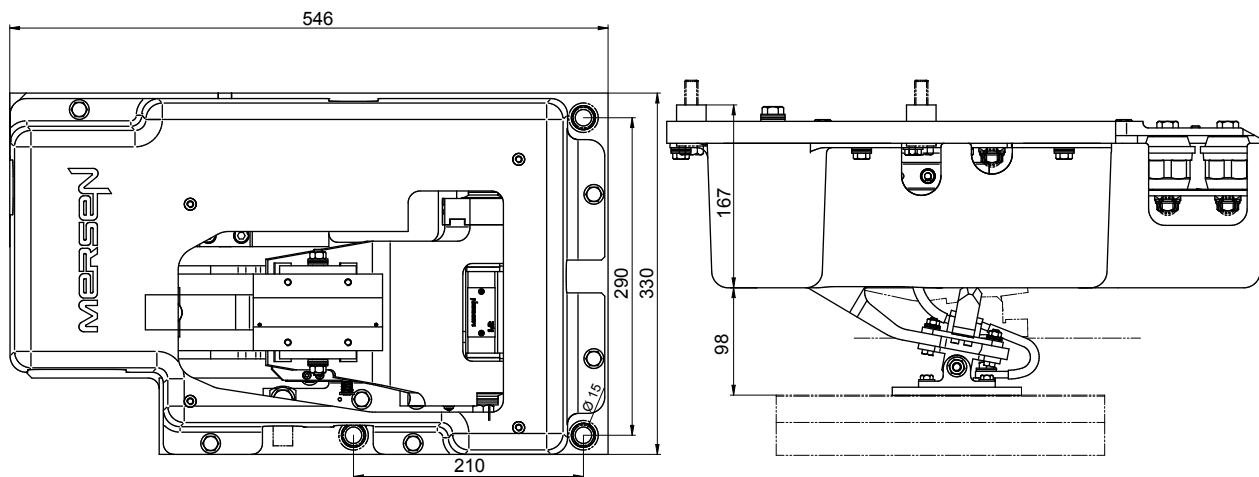

Static contact

FUNCTIONS

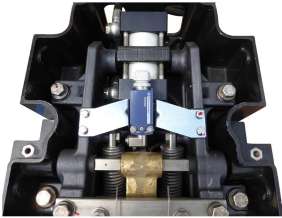

Retraction position indication

To inform the driver of the retracted position of the CCD, Mersen integrate a micro-switch to relay the information of the position.

This microswitch is compatible with all traction battery voltage supply (12, 24, 48 and 110VDC).

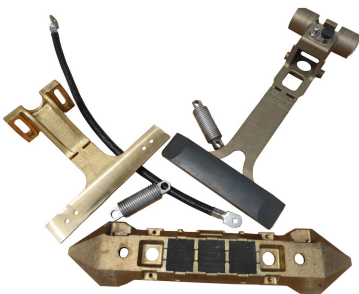

Spare part kits

Mersen will supply you all the Spare parts kits to increase the life time and guarantee a reliable service of your current collector devices.

- cables,
- fuses,
- replacement shoes and arms,
- hardware,
- and all necessary components

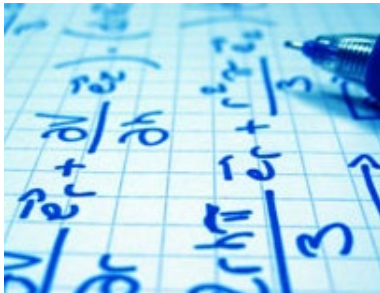

Training and technical support

Mersen team can help you for training your Maintenance team and for commissioning your new installations all around the world

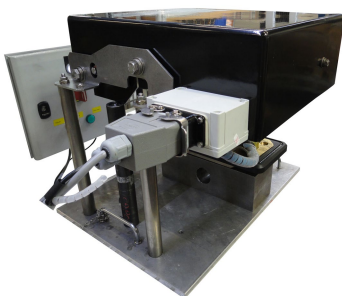

Tooling

Beside the spare parts, Mersen can supply the necessary tooling to set perfectly your CCD to the technical requirements of your grid and optimize their use.

High, Low and nominal positions can be set, also, the tool include a pressure measurement system to check the pressure of the CCD on the 3rd rail.

This tool is mandatory to succeed the maintenance when the great overhaul to guarantee a reliable service and longer life time of your CCD fleet



LCC; RAMS; Type tests

All around the world, Mersen technical team can help you for technical support and can offer you customized training sessions for your Maintenance team.

ACCESSORIES

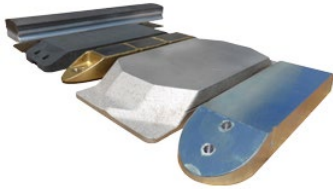

Brushes

Catalog number	Package
Cast Iron Shoe	1 piece
Copper shoe	1 piece
Cupro Alu shoe	1 piece
Graphite Shoe	1 piece
Steel shoe	1 piece



Y232597A

Traction fuses

Catalog number	Item number	Package	Weight
CC 7,5 GRC 123 D19SI 0500	C221216A	1 piece	2.3 kg
CC 7,5 GRC 123 D19SI 0600	K1018748A	1 piece	2.2 kg
CC 7,5 GRC 123 D19SI 0700	Y232597A	1 piece	2.3 kg
CC 7,5 GRC 123 TTF 0500	D090439A	1 piece	2 kg
CC 7,5 GRC 123 TTF 0600	H239207A	1 piece	2.2 kg
CC 7,5 GRC 123 TTF 0700	N1013714A	1 piece	2.3 kg
MICROSWTCH HOLDER SIZE 12X	Q1049941A	1 piece	0.15 kg