

Compact and Manual Retraction

with Integrated Fusebox

CURRENT COLLECTOR DEVICES (CCD)

CCD FOR STANDARD BOGIE

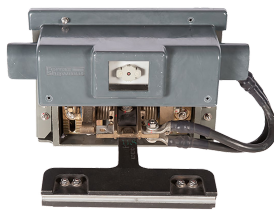

Current collector devices are used by Metro to collect the energy from the third rail to energize the Electrical Multiple Unit installed in the trailers.

Since 40 years, Mersen offer the largest range of Current Collector Devices of the market with almost 200 applications running every day all over the world.

The comprehensive range of CCD for Metro is designed for all kind of configurations:

- Regular steel wheel Metro
- Pneumatic wheel Metro,
- Monorail and
- Driverless metro applications

They can operate under 750VDC and 1.500VDC.

In this catalog, all technologies can be customized to your technical environments and available space on your bogie.

The sliding shoes can be retracted manually or using a pneumatic system also the CCD can be fixed on a beam and integrate a DC fuse protection and more functionalities.

All those technologies are proven and have shown their reliability every day since 40 years.

Some references for CCD for standard bogies:

Beijing metro (CN), Cairo metro (EG), Izmir metro (TR), San Paulo metro (BR), Tehran metro (IR), Tianjin metro (CN), Toronto metro (CA), Wuhan metro (CN),...

FEATURES & BENEFITS

- Proven technology since 40 years with more than 200 applications running every day
- CCD's dimensions and characteristics can be customized to your application
- Minimum weight, especially low dynamic mass
- Low noise level
- Extremely compact
- Cost effective, proven technologies and simple fixing
- Low cost maintenance

APPLICATIONS

- Third rail applications for Metro

STANDARDS

- IEC 61373



Compact and Manual Retraction

with Integrated Fusebox

TECHNICAL DATA OVERVIEW

Voltage DC	750 VDC
Amper (A)	800 A
Speed/Characteristic	90 km/h
Working Temperature	-40°C / +25°C
Pressure of the Shoe	120N ±20%
Humidity	90%

DIMENSIONS

Compact and manual retraction with integrated fuse box - contact from the bottom
 Dwg 1026868

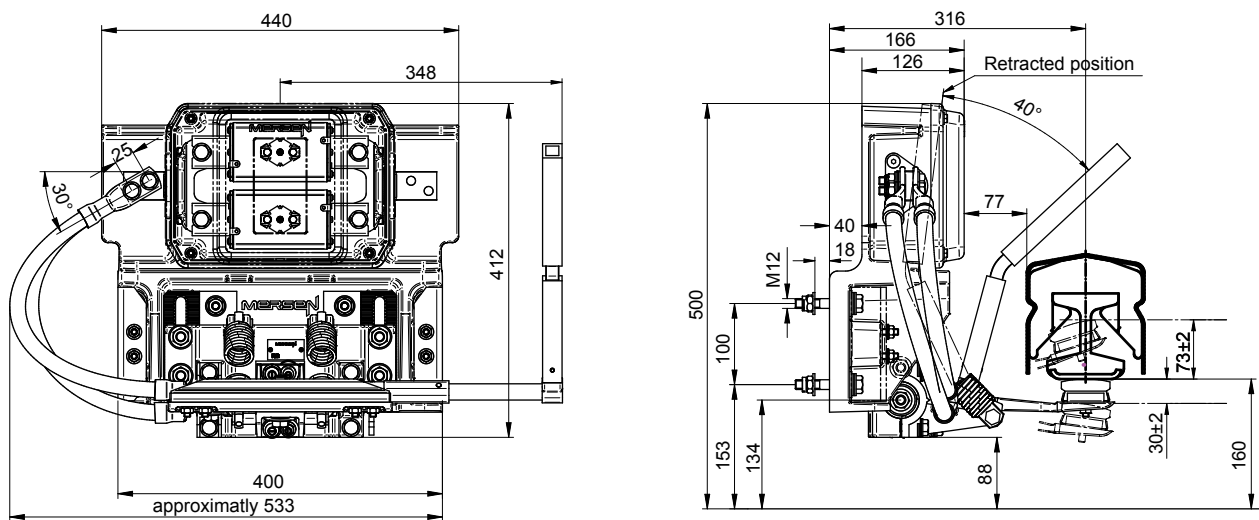

MERSEN reserves the right to change, update or correct, without notice, any information contained in this datasheet.

Compact and Manual Retraction

with Integrated Fusebox

FUNCTIONS



Pressure controller system (smart and connected function) (patented)

Mersen innovate in offering the possibility to equip the CCD's with a sensor to measure the contact force of the CCD against the third rail all along the track with possibility to record this measurement. Too much pressure force and the mileage of the shoe will be shorten, too less and there will be a risk of losing the contact and generate arcing.



Temperature measurement (smart and connected function)

In case of a broken arm, the motor car and the trailers will run under failed mode (3 CCD collecting energy instead of 4). Mersen have developed a system which measure live the temperature of the CCD and bring this information to the TMS.

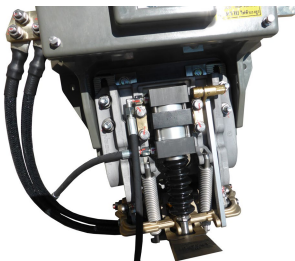

Pneumatic retraction

When needed, CCD can be retracted.

Two ways exists, with the use of an air cylinder or manually with a retraction lever.

Both are equipped with a locking system to secure the retracted position.

Air cylinder need 6 Bars of pressure to retract the arm.

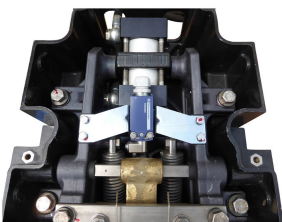

Retraction position indication

To inform the driver of the retracted position of the CCD, Mersen can integrate a micro-switch to relay the information of the position.

This microswitch is compatible with all traction battery voltage supply (12, 24, 48 and 110VDC).

Compact and Manual Retraction

with Integrated Fusebox

FUNCTIONS



Shoe material

Mersen can propose different Shoe materials - Copper; Graphite; Cast iron; Steel; Cupro Alu adapted to your third rail.

Once they are worn, it is very easy to change them for new ones supplied by Mersen.



Weak link

To secure your CCD in case of shock, your CCD can be equipped with a weak link.

When the CCD hits an obstacle, the arm will break at the weak link section and leave in safe condition the CCD device.



Broken arm detection device

In case of a broken arm, the motor car and the trailers will run under failed mode (3 CCD instead of 4).

Mersen have innovated by proposing a combination of mechanical and electrical systems which detect instantaneously a broken arm and will inform the driver.

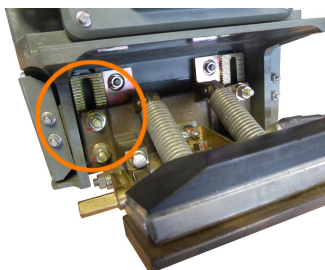

Adjusting rack

The CCD are equipped with an adjusting rack in order to adjust the shoe in vertical position in relation to the wheel overhauling and reprofiling wheel.

This adjusting rack can allow 40mm adjustment (pitch = 4mm)



On a beam

The CCD can be installed on a beam to adjust the position of the CCD from the bogie vs the position of the 3rd rail

Compact and Manual Retraction

with Integrated Fusebox

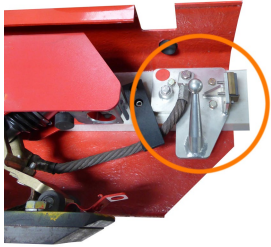

Work shop plug

The CCD can be equipped with a work shop plug in case you need to power the train when the third rail is not available (in the work shop).



Painting of Steel covers

Mersen can paint the covers or mass taint the isolated plastic frame of your CCD to the color specified by you, for purely cosmetic reasons.

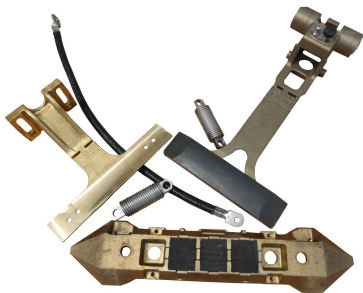

Spare part kits

Mersen will supply you all Spare parts kits to increase the life time and guarantee a reliable service of your current collector devices.

- cables,
- fuses,
- replacement shoes and arms,
- hardware,
- and all necessary components



Training and technical support

Mersen team can help you for training your Maintenance team and for commissioning your new installations all around the world

Compact and Manual Retraction with Integrated Fusebox



Tooling

Beside the spare parts, Mersen can supply the necessary tooling to set perfectly your CCD to the technical requirements of your grid and optimize their use.

High, Low and nominal positions can be set, also, the tool include a pressure measurement system to check the pressure of the CCD on the 3rd rail.

This tool is mandatory to succeed the maintenance when the great overhaul to guarantee a reliable service and longer life time of your CCD fleet



LCC; RAMS; Type tests

All around the world, Mersen technical team can help you for technical support and can offer you customized training sessions for your Maintenance team.

ACCESSORIES



Manual CCD lever

Manual operation handles

Catalog number	Package	Weight
Manual operation handles		
ON BOARD MANUAL CCD LEVER	1 piece	0.4 kg

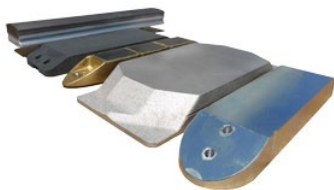

Brushes

Catalog number	Package
Brushes	
Cast Iron Shoe	1 piece
Copper shoe	1 piece
Cupro Alu shoe	1 piece
Graphite Shoe	1 piece
Steel shoe	1 piece

MERSEN reserves the right to change, update or correct, without notice, any information contained in this datasheet.

Compact and Manual Retraction with Integrated Fusebox

ACCESSORIES



Connexion cables

Cables

Braided cables
Braided cables



Y232597A

Traction fuses

Catalog number	Item number	Package	Weight
Traction fuses			
CC 7,5 GRC 123 D19SI 0500	C221216A	1 piece	2.3 kg
CC 7,5 GRC 123 D19SI 0600	K1018748A	1 piece	2.2 kg
CC 7,5 GRC 123 D19SI 0700	Y232597A	1 piece	2.3 kg
CC 7,5 GRC 123 TTF 0500	D090439A	1 piece	2 kg
CC 7,5 GRC 123 TTF 0600	H239207A	1 piece	2.2 kg
CC 7,5 GRC 123 TTF 0700	N1013714A	1 piece	2.3 kg
MICROSWTCH HOLDER SIZE 12X	Q1049941A	1 piece	0.15 kg